

Data sheet Product AKG_D033_24_

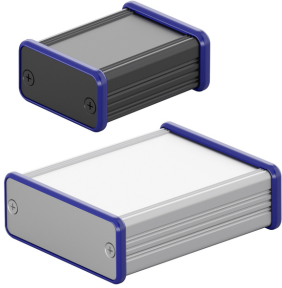

Cases>Miniature aluminium casing

Miniature aluminium casing, anti-slip

- tube case consisting of AL-profiles which are slotted into each other and screwed together
- anti-slip and save application as a bench case due to revolving sealing, cobalt blue (similar to **RAL 5013**)
- guiding groove for insertion of non-standardized PCBs or mounting plates with a thickness of 1.6-1.8 mm
- special designs and treatments, modifications and options according to your requests
- different colours of the sealing and surface upon request

Features

surface:

- black anodised
- natural colour anodised

length:

50 mm / 80 mm / 100 mm

Technical Drawing

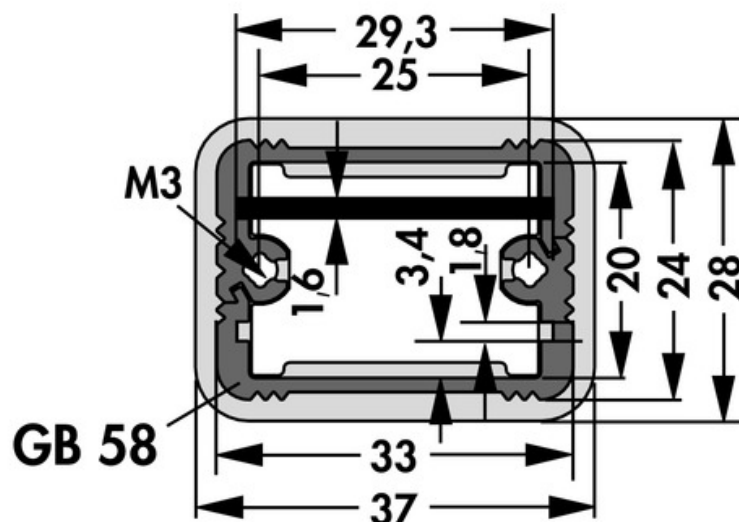

height:

28 mm

width:

37 mm

D:

29.3 mm

Fischer Elektronik GmbH & Co. KG
DEUTSCHLAND • GERMANY • ALLEMAGNE

Nottebohmstraße 28
58511 Lüdenscheid

Telefon +49 2351 435-0
Telefax +49 2351 45754

info@fischerelektronik.de
www.fischerelektronik.de