



Ammonia Gas Sensor NH3/SR-200

NH3 Gas Sensor in Standard Housing

Applications

- Leak Detection
- Discontinuous Measurement
- Safety and Environmental Control

Measurement

Operation Principle	3-Electrode Electrochemical
Nominal Range	0 - 100 ppm
Maximum Overload	200 ppm
Inboard Filter	-
Output Signal	90 ± 18 nA/ppm
Resolution (Electronics dependent)	< 0.6 ppm
T90 Response Time	< 50 s
Typical Baseline Range (pure air, 20°C)	-4 ppm to 4 ppm
Maximum Zero Shift (+20°C to +40°C)	-8 ppm
Repeatability	< 3% of signal
Output Linearity	< 5 % full scale
Gain (Only applies to 4-Electrode sensors)	-

Performance data recorded at 20 – 25 °C, 30 - 50% RH, 900 - 1100 mbar

For further information about usage of Membrapor sensors, see application note [MEM1](#). The data contained in this document is for guidance only. Membrapor AG accepts no liability for any consequential losses, injury or damage resulting from the use of this document or from any omissions or errors herein. Customers should test under their own conditions to ensure that the sensors are suitable for their own requirements.



Ammonia Gas Sensor NH3/SR-200

Electrical

Rec. Load Resistor	10 - 33 Ω
Bias (V_Sens-V_Ref)	not allowed
Conformity to RoHS directive	RoHS Compliance

Environmental

Relative Humidity Range	15 % to 90 % RH non-condensing
Temperature Range	-10 °C to 50 °C
Pressure Range	Atmospheric \pm 10%
Pressure Coefficient	N.D.
Humidity Effect ¹⁾	< 4 ppm

1) Abrupt changes in rel. Humidity causes a short-term transient signal.

Lifetime

Expected Operation Life	2 years in air
Expected Long Term Output Drift in air	< 5 % signal loss per 6 months
Filter Life	
Storage Life	6 months in container
Rec. Storage Temperature	5°C - 20°C
Warranty Period	12 months from date of dispatch

Performance data recorded at 20 – 25 °C, 30 - 50% RH, 900 - 1100 mbar

For further information about usage of Membrapor sensors, see application note [MEM1](#). The data contained in this document is for guidance only. Membrapor AG accepts no liability for any consequential losses, injury or damage resulting from the use of this document or from any omissions or errors herein. Customers should test under their own conditions to ensure that the sensors are suitable for their own requirements.



Ammonia Gas Sensor NH3/SR-200

Standard-Size Outline Dimensions

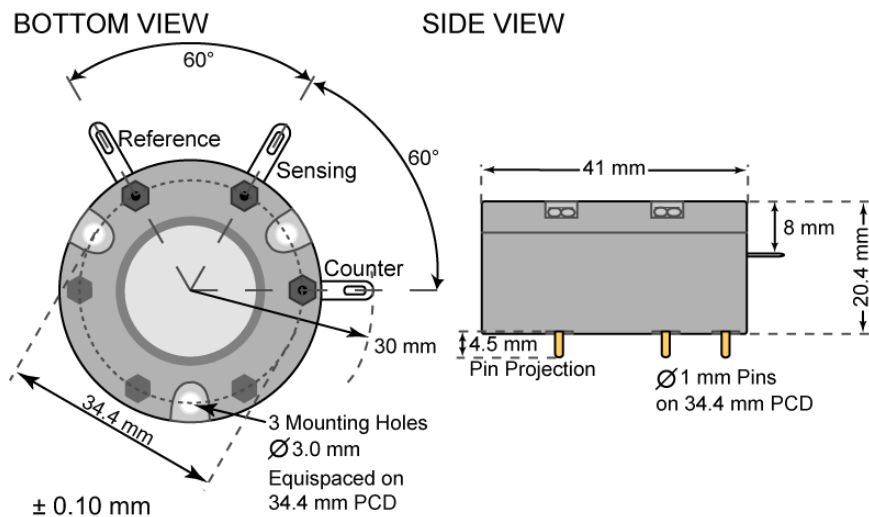

Mechanical

Weight	32 g
Orientation	Any
Housing material	Polycarbonate

Performance data recorded at 20 – 25 °C, 30 - 50% RH, 900 - 1100 mbar

For further information about usage of Membrapor sensors, see application note [MEM1](#). The data contained in this document is for guidance only. Membrapor AG accepts no liability for any consequential losses, injury or damage resulting from the use of this document or from any omissions or errors herein. Customers should test under their own conditions to ensure that the sensors are suitable for their own requirements.



Ammonia Gas Sensor NH3/SR-200

Cross Sensitivity Data

The table below does not claim to be complete. Interfering gases should not be used for calibration. Please contact Membrapor AG for further support regarding cross sensitivities.

Interfering Gas	Concentration [ppm]	Reading [ppm]
Cl ₂	20	-55
CO	300	0
CO ₂	20000	0
H ₂	200	0
H ₂ S	20	7
NO	20	-1
NO ₂	20	-20
SO ₂	20	-7

Important Application Notes

- Long term exposures and high concentrations of SO₂, H₂S, NO, NO₂ can affect the performance characteristics.

Performance data recorded at 20 – 25 °C, 30 - 50% RH, 900 - 1100 mbar

For further information about usage of Membrapor sensors, see application note [MEM1](#). The data contained in this document is for guidance only. Membrapor AG accepts no liability for any consequential losses, injury or damage resulting from the use of this document or from any omissions or errors herein. Customers should test under their own conditions to ensure that the sensors are suitable for their own requirements.