

Data sheet Product PL H 24 UL

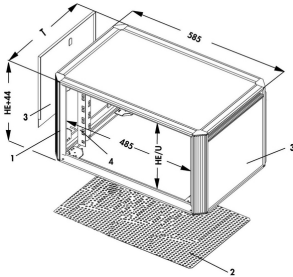

19" cases PLUSLINE

- basic case with modular rails 19" variable in depth for application of built-in parts, colour **ultramarine blue (RAL 5002)**
- bench case with recessed grips
- side panels detachable
- possibility to mount shelves, intermediate shelves with/without telescopic rails
- suitable for steady-state use
- additional payload max. 100 kg
- 19" assembly dimensions according to IEC 297-1 (DIN 41494)
- all accessories available on request
- **contents of delivery:** basic case, assembled

1 = basic case; **2** = bottom with ventilation slots (**option BL**); **3** = firmly mounted side panel (**PL H**); **4** = 19" grid struts

Features

height unit:

24

Technical Drawing

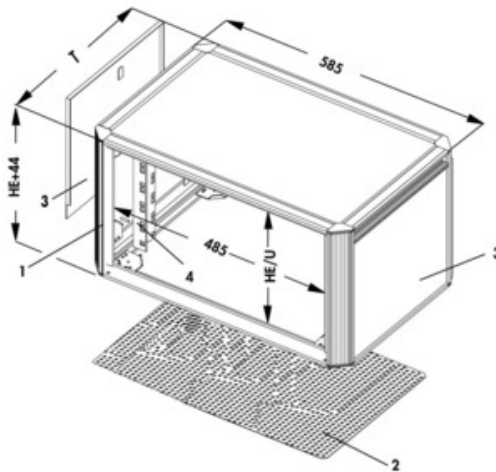

depth

500 mm

: