

General data

<b>Dimensional class:</b>	high
<b>Standard colour:</b>	green for wave soldering, black for reflow soldering
<b>Pitches:</b>	imperial 10.16 mm (.400 in)
<b>Screw dimension:</b>	M4
<b>Recommended/highest tightening torque:</b>	1.2/1.5 Nm (10.62/13.28 lbf-in)
<b>PCB thickness:</b>	max. 2.4 mm (.094 in)
<b>PCB hole diameter:</b>	min. 1.5 mm (.059 in)
<b>Stripping length:</b>	10.5 ÷ 11.5 mm (.41 ÷ .45 in)
<b>Operating temperature range:</b>	-40 °C ÷ +130 °C (-40 °F ÷ +266 °F)
<b>STH operating temperature range:</b>	-40 °C ÷ +130 °C (-40 °F ÷ +266 °F)
<b>Contact resistance:</b>	<15 mΩ
<b>Insulation resistance:</b>	>10 <sup>9</sup> Ω (500V DC)
<b>Insulating material group:</b>	I (CTI ≥ 600V)

Certifications

UL (n. E167473)

- 600 V - 60 A - 20÷6 AWG - 1.2 Nm for 10.16 mm pitch (version "S")
- 600 V - 57 A - 20÷6 AWG - 1.2 Nm for 10.16 mm pitch (version "Z")
- 300 V - 60 A - 20÷6 AWG - 1.2 Nm for 10.16 mm pitch (version "D")

VDE (n. 40036991)

- 1000 V - T 110 - 76 A - 16 mm<sup>2</sup> solid (57 A - 10 mm<sup>2</sup> stranded) for 10.16 mm pitch (version "S")
- 1000 V - T 110 - 72 A - 16 mm<sup>2</sup> solid (57 A - 10 mm<sup>2</sup> stranded) for 10.16 mm pitch (version "Z")
- 450 V - T 110 - 76 A - 16 mm<sup>2</sup> solid (57 A - 10 mm<sup>2</sup> stranded) for 10.16 mm pitch (version "D")

Application values for end-use equipment have to be in accordance to norms and applicable to it. The certifications of some product's versions could be pending, for more detailed and updated data please refer to our web site [www.sauro.net](http://www.sauro.net) or your representative Sales Manager

PCB layout "S" version

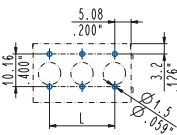

PCB layout "Z" version

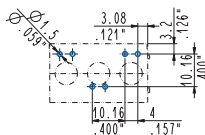

PCB layout "D" version

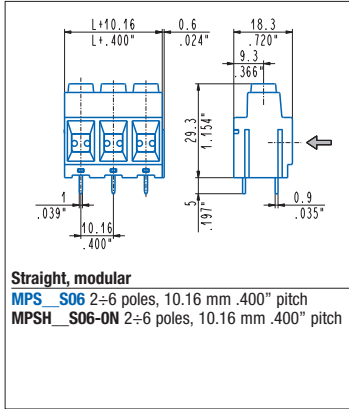
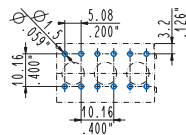

**Straight, modular**  
**MPS\_S06** 2÷6 poles, 10.16 mm .400" pitch  
**MPSH\_S06-ON** 2÷6 poles, 10.16 mm .400" pitch

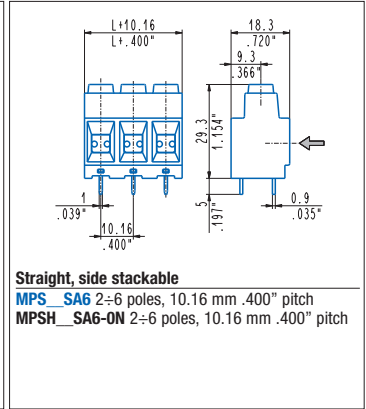

**Straight, side stackable**  
**MPS\_SAG** 2÷6 poles, 10.16 mm .400" pitch  
**MPSH\_SAG-ON** 2÷6 poles, 10.16 mm .400" pitch

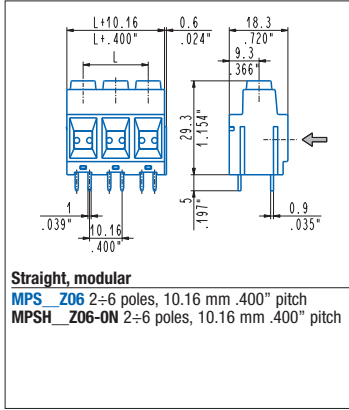

**Straight, modular**  
**MPS\_Z06** 2÷6 poles, 10.16 mm .400" pitch  
**MPSH\_Z06-ON** 2÷6 poles, 10.16 mm .400" pitch

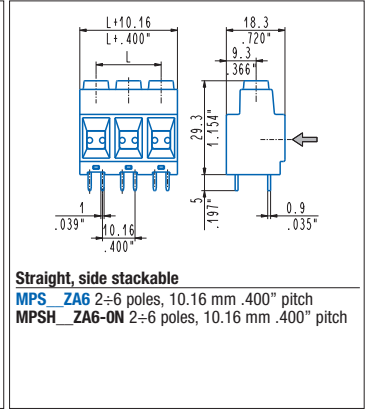

**Straight, side stackable**  
**MPS\_ZA6** 2÷6 poles, 10.16 mm .400" pitch  
**MPSH\_ZA6-ON** 2÷6 poles, 10.16 mm .400" pitch

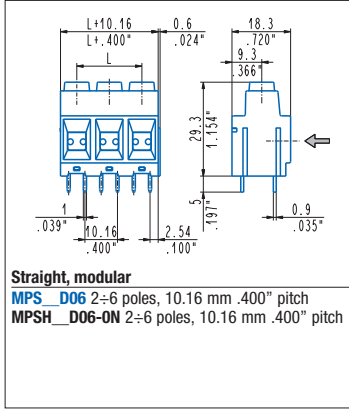

**Straight, modular**  
**MPS\_D06** 2÷6 poles, 10.16 mm .400" pitch  
**MPSH\_D06-ON** 2÷6 poles, 10.16 mm .400" pitch

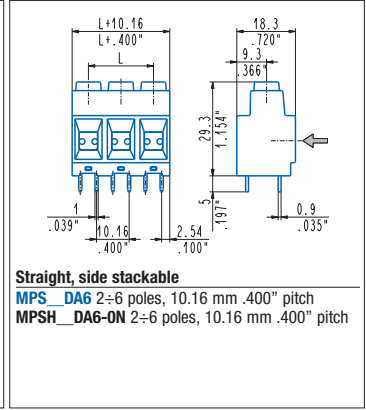

**Straight, side stackable**  
**MPS\_DA6** 2÷6 poles, 10.16 mm .400" pitch  
**MPSH\_DA6-ON** 2÷6 poles, 10.16 mm .400" pitch

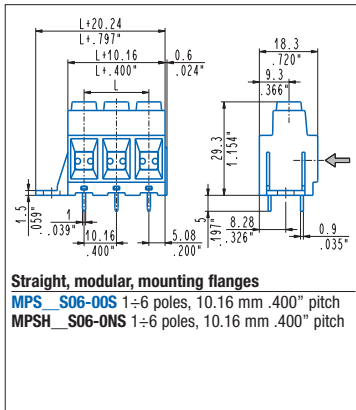

**Straight, modular, mounting flanges**  
**MPS\_S06-00S** 1÷6 poles, 10.16 mm .400" pitch  
**MPSH\_S06-00S** 1÷6 poles, 10.16 mm .400" pitch

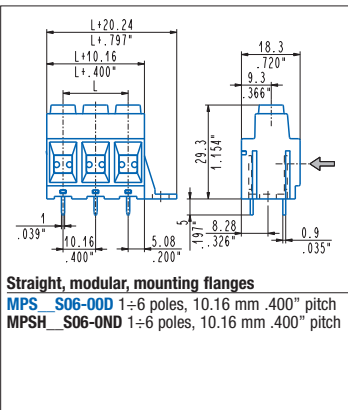

**Straight, modular, mounting flanges**  
**MPS\_S06-00D** 1÷6 poles, 10.16 mm .400" pitch  
**MPSH\_S06-00D** 1÷6 poles, 10.16 mm .400" pitch

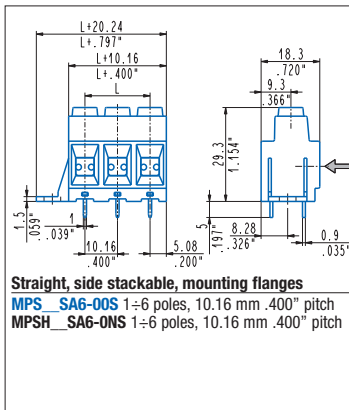

**Straight, side stackable, mounting flanges**  
**MPS\_SAG-00S** 1÷6 poles, 10.16 mm .400" pitch  
**MPSH\_SAG-00S** 1÷6 poles, 10.16 mm .400" pitch

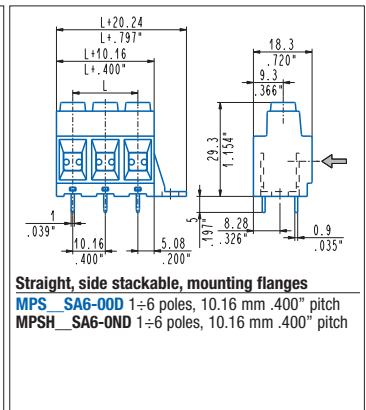

**Straight, side stackable, mounting flanges**  
**MPS\_SAG-00D** 1÷6 poles, 10.16 mm .400" pitch  
**MPSH\_SAG-00D** 1÷6 poles, 10.16 mm .400" pitch

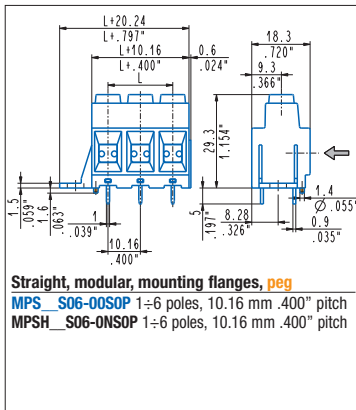

**Straight, modular, mounting flanges, peg**  
**MPS\_S06-00SOP** 1÷6 poles, 10.16 mm .400" pitch  
**MPSH\_S06-00SOP** 1÷6 poles, 10.16 mm .400" pitch

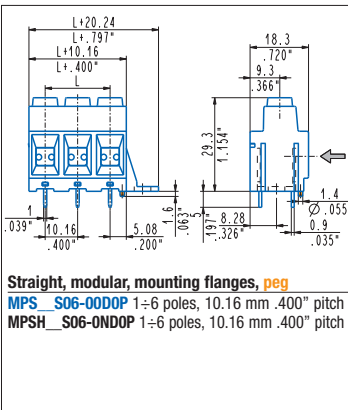

**Straight, modular, mounting flanges, peg**  
**MPS\_S06-00DOP** 1÷6 poles, 10.16 mm .400" pitch  
**MPSH\_S06-00DOP** 1÷6 poles, 10.16 mm .400" pitch

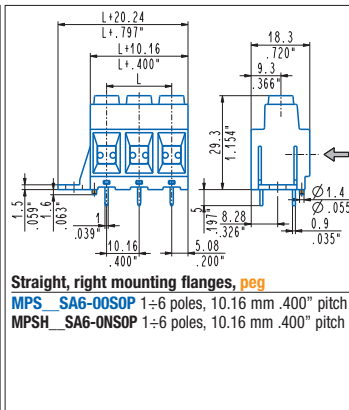

**Straight, right mounting flanges, peg**  
**MPS\_SAG-00SOP** 1÷6 poles, 10.16 mm .400" pitch  
**MPSH\_SAG-00SOP** 1÷6 poles, 10.16 mm .400" pitch

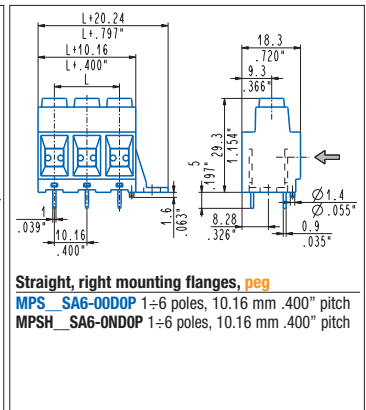

**Straight, right mounting flanges, peg**  
**MPS\_SAG-00DOP** 1÷6 poles, 10.16 mm .400" pitch  
**MPSH\_SAG-00DOP** 1÷6 poles, 10.16 mm .400" pitch

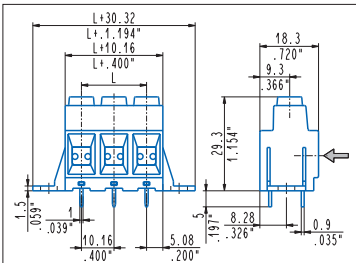

**Straight, mounting flanges**  
**MPS\_SV6** 2÷6 poles, 10.16 mm .400" pitch  
**MPSH\_SV6-ON** 2÷6 poles, 10.16 mm .400" pitch

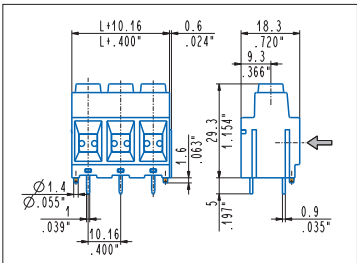

**Straight, modular, pegs**  
**MPS\_S06-0000P** 2÷6 poles, 10.16 mm .400" pitch  
**MPSH\_S06-0000P** 2÷6 poles, 10.16 mm .400" pitch

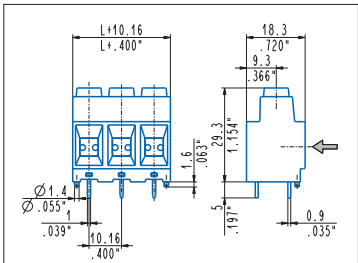

**Straight, side stackable, pegs**  
**MPS\_SA6-0000P** 2÷6 poles, 10.16 mm .400" pitch  
**MPSH\_SA6-0000P** 2÷6 poles, 10.16 mm .400" pitch

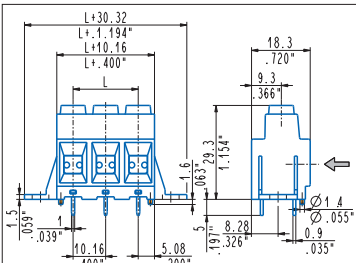

**Straight, mounting flanges, pegs**  
**MPS\_SV6-0000P** 2÷6 poles, 10.16 mm .400" pitch  
**MPSH\_SV6-0000P** 2÷6 poles, 10.16 mm .400" pitch

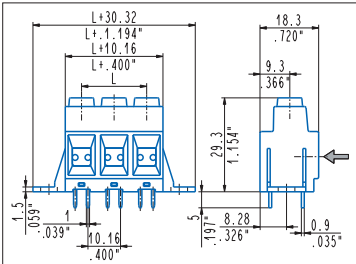

**Straight, mounting flanges**  
**MPS\_ZV6** 2÷6 poles, 10.16 mm .400" pitch  
**MPSH\_ZV6-ON** 2÷6 poles, 10.16 mm .400" pitch

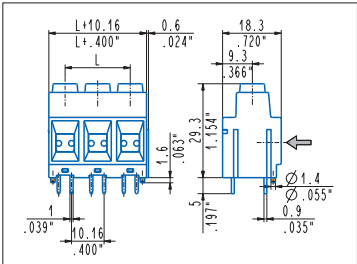

**Straight, modular, pegs**  
**MPS\_Z06-0000P** 2÷6 poles, 10.16 mm .400" pitch  
**MPSH\_Z06-0000P** 2÷6 poles, 10.16 mm .400" pitch

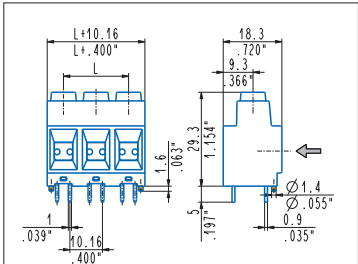

**Straight, side stackable, pegs**  
**MPS\_ZA6-0000P** 2÷6 poles, 10.16 mm .400" pitch  
**MPSH\_ZA6-0000P** 2÷6 poles, 10.16 mm .400" pitch

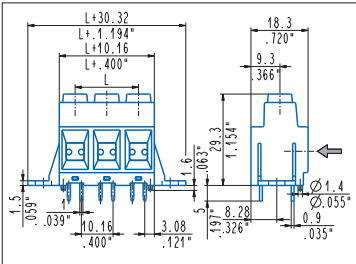

**Straight, mounting flanges, pegs**  
**MPS\_ZV6-0000P** 2÷6 poles, 10.16 mm .400" pitch  
**MPSH\_ZV6-0000P** 2÷6 poles, 10.16 mm .400" pitch

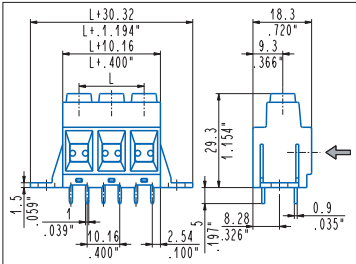

**Straight, mounting flanges**  
**MPS\_DV6** 2÷6 poles, 10.16 mm .400" pitch  
**MPSH\_DV6-ON** 2÷6 poles, 10.16 mm .400" pitch

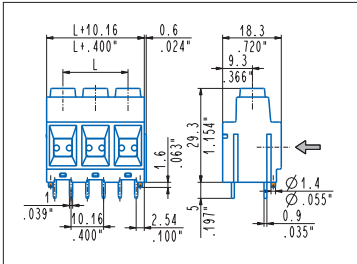

**Straight, modular, pegs**  
**MPS\_D06-0000P** 2÷6 poles, 10.16 mm .400" pitch  
**MPSH\_D06-0000P** 2÷6 poles, 10.16 mm .400" pitch

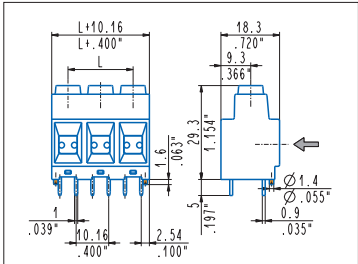

**Straight, side stackable, pegs**  
**MPS\_DA6-0000P** 2÷6 poles, 10.16 mm .400" pitch  
**MPSH\_DA6-0000P** 2÷6 poles, 10.16 mm .400" pitch

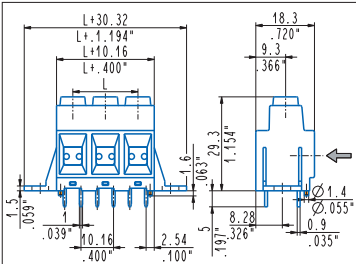

**Straight, mounting flanges, pegs**  
**MPS\_DV6-0000P** 1÷6 poles, 10.16 mm .400" pitch  
**MPSH\_DV6-0000P** 1÷6 poles, 10.16 mm .400" pitch

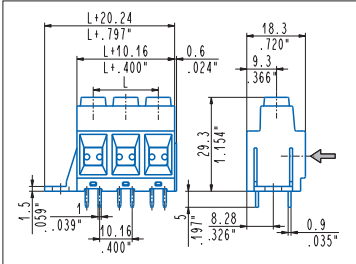

**Straight, modular, mounting flanges**  
**MPS\_Z06-00S** 2÷6 poles, 10.16 mm .400" pitch  
**MPSH\_Z06-00S** 2÷6 poles, 10.16 mm .400" pitch

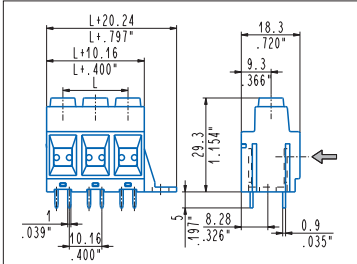

**Straight, modular, mounting flanges**  
**MPS\_Z06-00D** 2÷6 poles, 10.16 mm .400" pitch  
**MPSH\_Z06-00D** 2÷6 poles, 10.16 mm .400" pitch

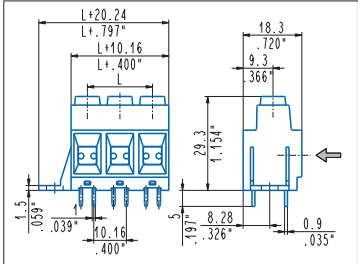

**Straight, side stackable, mounting flanges**  
**MPS\_ZA6-00S** 2÷6 poles, 10.16 mm .400" pitch  
**MPSH\_ZA6-00S** 2÷6 poles, 10.16 mm .400" pitch

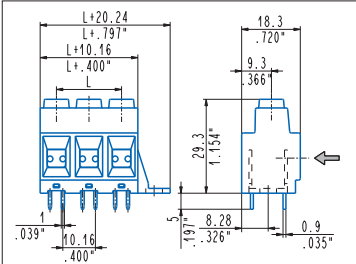

**Straight, side stackable, mounting flanges**  
**MPS\_ZA6-00D** 2÷6 poles, 10.16 mm .400" pitch  
**MPSH\_ZA6-00D** 2÷6 poles, 10.16 mm .400" pitch

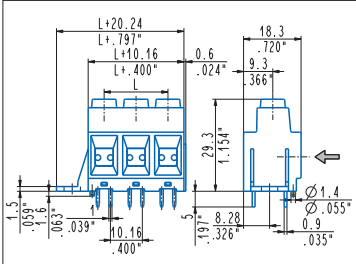

**Straight, modular, mounting flanges, peg**  
**MPS\_Z06-00SOP** 2÷6 poles, 10.16 mm .400" pitch  
**MPSH\_Z06-00SOP** 2÷6 poles, 10.16 mm .400" pitch

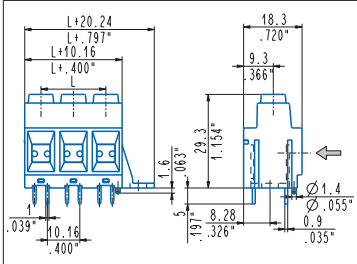

**Straight, modular, mounting flanges, peg**  
**MPS\_Z06-00DOP** 2÷6 poles, 10.16 mm .400" pitch  
**MPSH\_Z06-00DOP** 2÷6 poles, 10.16 mm .400" pitch

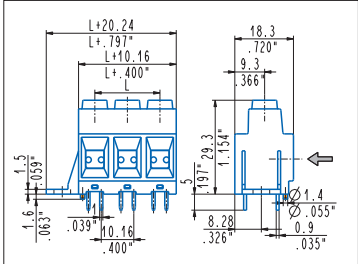

**Straight, right mounting flanges, pegs**  
**MPS\_ZA6-00SOP** 2÷6 poles, 10.16 mm .400" pitch  
**MPSH\_ZA6-00SOP** 2÷6 poles, 10.16 mm .400" pitch

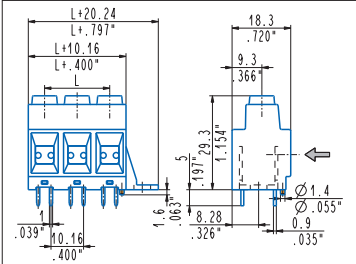

**Straight, right mounting flanges, peg**  
**MPS\_ZA6-00DOP** 2÷6 poles, 10.16 mm .400" pitch  
**MPSH\_ZA6-00DOP** 2÷6 poles, 10.16 mm .400" pitch

Your drawings and notes

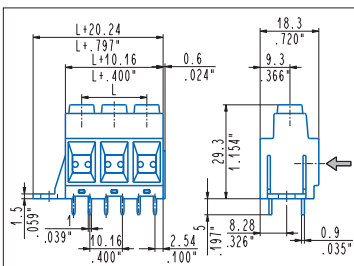
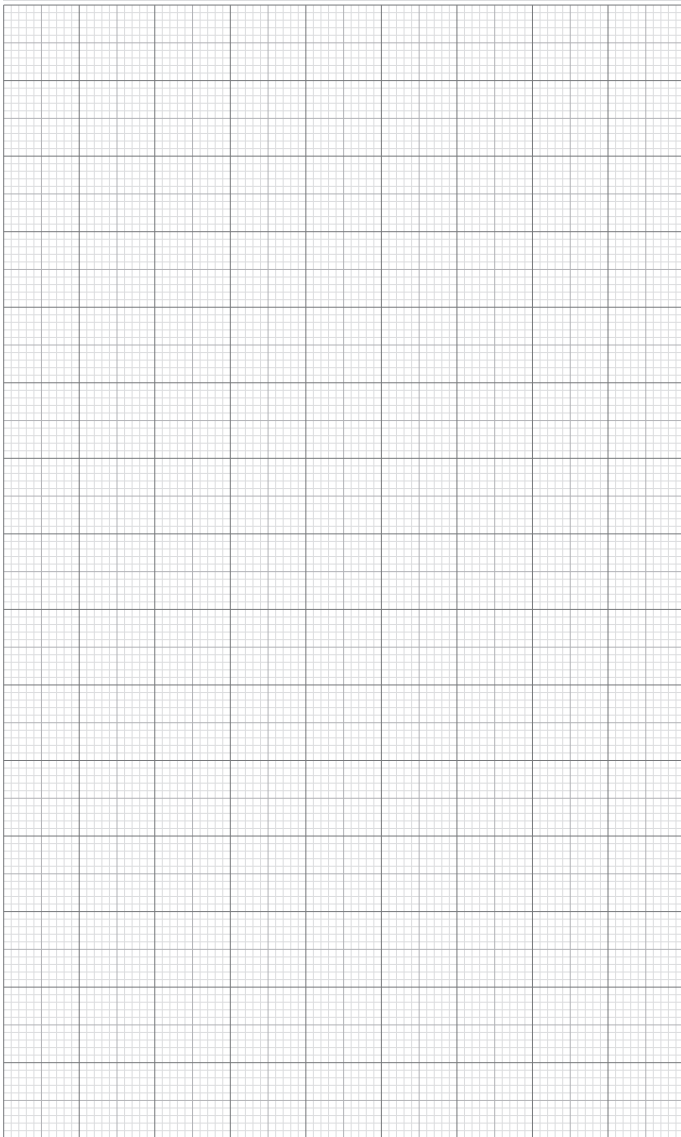

**Straight, modular, mounting flanges**  
**MPS\_D06-00S** 1÷6 poles, 10.16 mm .400" pitch  
**MPSH\_D06-0NS** 1÷6 poles, 10.16 mm .400" pitch

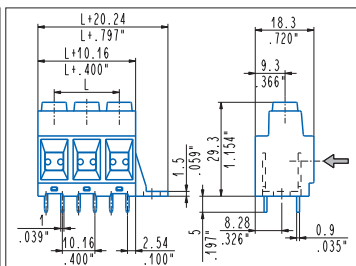

**Straight, side stackable, mounting flanges**  
**MPS\_DA6-00D** 1÷6 poles, 10.16 mm .400" pitch  
**MPSH\_DA6-0ND** 1÷6 poles, 10.16 mm .400" pitch

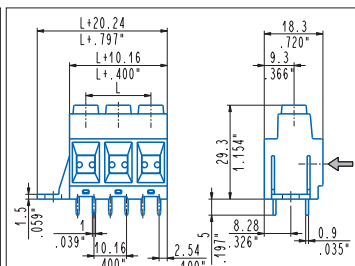

**Straight, side stackable, mounting flanges**  
**MPS\_DA6-00S** 1÷6 poles, 10.16 mm .400" pitch  
**MPSH\_DA6-0NS** 1÷6 poles, 10.16 mm .400" pitch

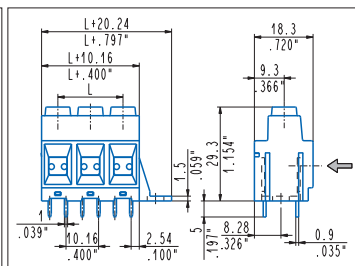

**Straight, modular, mounting flanges**  
**MPS\_D06-00D** 1÷6 poles, 10.16 mm .400" pitch  
**MPSH\_D06-0ND** 1÷6 poles, 10.16 mm .400" pitch

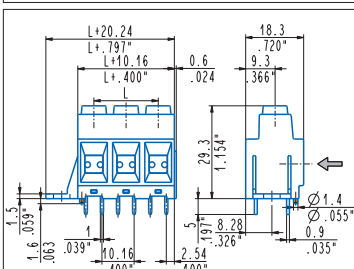

**Straight, modular, mounting flanges, peg**  
**MPS\_D06-00SOP** 1÷6 poles, 10.16 mm .400" pitch  
**MPSH\_D06-0NSOP** 1÷6 poles, 10.16 mm .400" pitch

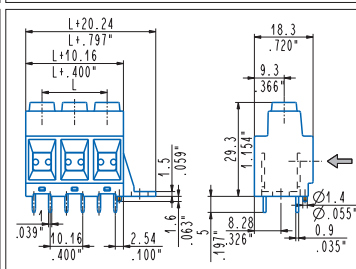

**Straight, right mounting flanges, peg**  
**MPS\_DA6-00DOP** 1÷6 poles, 10.16 mm .400" pitch  
**MPSH\_DA6-0NDOP** 1÷6 poles, 10.16 mm .400" pitch

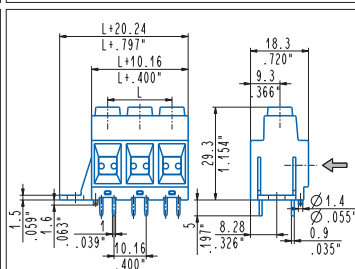

**Straight, right mounting flanges, peg**  
**MPS\_DA6-00SOP** 1÷6 poles, 10.16 mm .400" pitch  
**MPSH\_DA6-0NSOP** 1÷6 poles, 10.16 mm .400" pitch

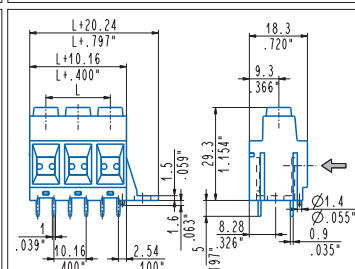

**Straight, modular, mounting flanges, peg**  
**MPS\_D06-00DOP** 1÷6 poles, 10.16 mm .400" pitch  
**MPSH\_D06-0NDOP** 1÷6 poles, 10.16 mm .400" pitch